

Determination of the Influence of the Speed of the Saw Cylinder of the Saw Gin on the Density, Speed and Composition of the Seed Roll

Akmal Umarov, Hamit Akhmedhodjaev, Kamola Ortiqova, Zohida Nasriddinova

Namangan Institute of Engineering and Technology, Namangan, Uzbekistan
Email: akmal.umarov@mail.ru, kamola90.90@inbox.ru, zohidanasriddinova450@gmail.com

How to cite this paper: Umarov, A., Akhmedhodjaev, H., Ortiqova, K. and Nasriddinova, Z. (2022) Determination of the Influence of the Speed of the Saw Cylinder of the Saw Gin on the Density, Speed and Composition of the Seed Roll. *Engineering*, 14, 131-137.

<https://doi.org/10.4236/eng.2022.143012>

Received: November 29, 2021

Accepted: March 22, 2022

Published: March 25, 2022

Copyright © 2022 by author(s) and Scientific Research Publishing Inc. This work is licensed under the Creative Commons Attribution International License (CC BY 4.0).

<http://creativecommons.org/licenses/by/4.0/>



Open Access

Abstract

The article consists of studying the influence of the speed of the saw cylinder on the quality of the fiber and the productivity of the machine, as well as on the change in the density and composition of the seed roll.

Keywords

Seed Cotton, Ginning of Cotton, Saw Gin Stand, Roll Box, Seed Roll, Profile of the Roll Box, Speed of the Feed Rolls, Density of the Seed Roll

1. Introduction

Special attention is paid to the development of the technology of primary processing of cotton, in particular, the process of separating fiber from seed (ginning), improving product quality and reducing costs through the widespread introduction of the latest achievements in production.

2. Methods

As can be seen from the literature [...], with an increase in the density of the seed roll, fiber defects appear which negatively affect the weaving process. To reduce the defects of ginning, the ginning process must be carried out with a relatively low density of the seed roll.

The creation of a seed roll when separating fiber from seed in gin depends on several factors. The main ones are the density, speed, fibrousness of the seed roll and the number of bare seeds. These factors affect the productivity of the machine and the quality of the resulting fiber.

Fiber quality depends on the density of the seed roll, increasing the density of the seed roll negatively affects the fiber and seeds. The main reason for the in-

crease in the density of the seed roll is the uneven supply of cotton by the feeder, the condition and speed of the saw, as well as the accumulation of bare seeds in the center of the roll box.

Scientists have obtained experimental data on the influence of the density of the seed roll on the quality of fiber and seed. These data show that the minimum damage to I-grade cotton with a seed roll density of 325 kg/m³, III-grade cotton with a seed roll density of 290 kg/m³ [1].

In order to determine the effect of the speed of the saw cylinder on the density of the seed roll, experiments were carried out at the DP-130 stand in the laboratory of the Namangan Institute of Engineering and Technology. The experiments were carried out on cotton of the selection grade C65-24, III-industrial grade of cotton, with a moisture content of 7.5% and weediness of 2.8% by hand. The experiments were carried out 3 times and their results are shown in **Table 1**.

Experiments were carried out with a saw diameter of 320 mm, at a speed of a saw cylinder 700, 730 and 760 rpm (**Table 1**). To determine the density of the seed roll, it was necessary to determine the volume of the roll box. For this, the technique described in [2] was used (**Figure 1**). It was accepted: the area of the roll box $S = 0.11 \text{ m}^2$, length $L = 0.53 \text{ m}$. The volume of the roll box was determined by the following formula:

$$V = S \cdot L = 0.11 \times 0.53 = 0.058 \text{ m}^3 \quad (1)$$

During the experiments, the machine was stopped, after which the mass of the seed roll was weighed on an electronic balance. To determine the density of the seed roll, the following formula was used (2):

$$\rho = \frac{m}{V} \quad (2)$$

As can be seen from the above, the density of the seed roll largely depends on the speed of the saw cylinder; with increasing speed, the density decreases.

With saw ginning, the speed parameters of the seed roll depend on the process of removing bare seeds. It has been determined that for uniform ginning, it is necessary to accelerate the withdrawal of fiber and seeds from the roll box of the saw gin.

It has been determined that with an increase in the density of the seed roll under the influence of an increase in the friction force on the side walls of the roll box, the speed of the seed roll decreases and, as a result, the productivity of ginning decreases [3].

A literature review [4] showed that the speed of the seed roll in the saw gin is different in different areas of the roll box. That is, in the area of the front apron of the camera (BCD), the speed V_{BCD} is 4 - 5 times less than the saw cylinder (**Figure 2**). As the study shows, when the speed of the seed roll in the roll box area of the grate (point A) is 100%, the speed at the D point was 130% - 160%, at the B point—102% - 103%, in the contact zone of the seed roll with the saw cylinder—220% - 230%.

In order to study the effect of the speed of the saw cylinder on the speed of the

seed roll, experiments were carried out in parallel with the above. The gin stand has the same profile as the production gin, but is shortened in width.

Table 1. The effect of the speed of the saw cylinder on the density of the seed roll.

Saw cylinder speed, rpm	Seed roll mass, g	Roll box volume, m ³	Density of the seed roll, kg/m ³
700	19,020	0.058	327.9
730	18,323	0.058	315.9
760	17,737	0.058	305.8

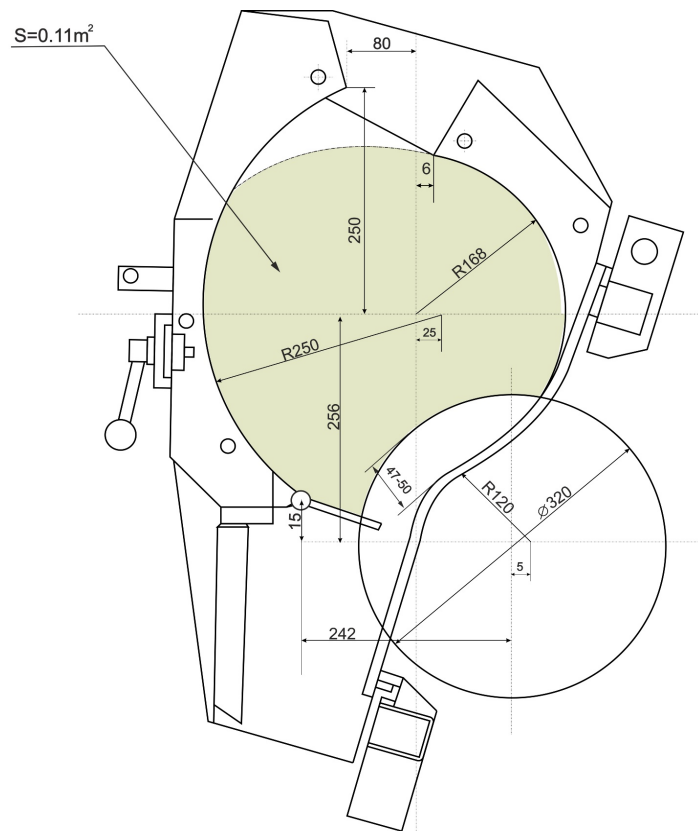

Figure 1. Diagram of the cross-section of the roll box of the saw gin.

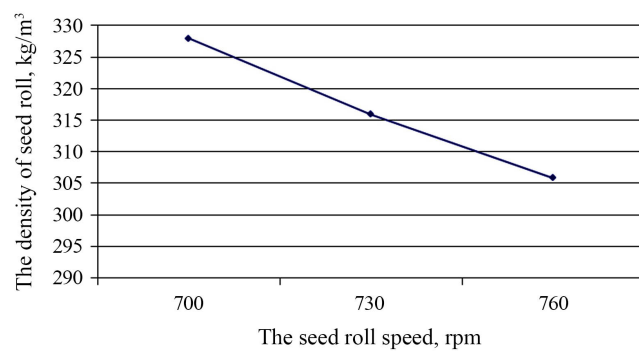

Figure 2. Graph of the effect of the speed of the saw cylinder on the density of the seed roll.

To assess the process inside the roll box, transparent plexiglass was used and, to visualize the trajectory of movement, part of the cotton was painted over in red (**Figure 3**). The saw cylinder speed was 700, 730 and 760 rpm, which was changed by a frequency converter. The saw diameter was 320 mm.

The lengths of each zone of the roll box were measured in advance. The frequency of experiments was three, the results were processed in Excel (**Table 2**).

As can be seen from the graph in **Figure 4**, when compared with the results of experiments obtained by scientists of the Scientific Center “Pakhtasanoat”, the regularity of the change in the speed of the seed roll corresponds, but the practical value of the speed of the seed roll is different, that is, the speed of the seed roll in the AB and CA zones is less, and in the BC zone it is more from given in the literature [5]. In addition, as the speed of the saw cylinder increases, the speed of the seed roll also increases.

On the research of gin, many scientific works have been carried out, as a result of which the saw gin is being improved. But the problem of ensuring a uniform density of the seed roll has not yet been solved. The reason for this is not a complete study of the composition of the seed roll.

In order to study the effect of the speed of the saw cylinder on the change in the composition of the seed roll, experimental studies were carried out. The experiments were carried out 3 times, their results are shown in **Table 3**.

In the experiments, the gin stand was stopped, and the seed roll from the roll box was divided into three fractions: completely bare seeds, semi-ginned seeds and non-ginned seeds (**Figure 5, Figure 6**).

Table 2. The effect of the speed of the saw cylinder on the speed of the seed roll.

Saw cylinder speed, rpm	Time, sec	Seed roll speed, m/s			
		Arc AB	Arc BC	Arc CA	Arc AC
700	1.42	0.76	2.49	0.69	0.84
730	1.33	0.81	2.53	0.75	0.90
760	1.25	0.87	2.57	0.80	0.96



Figure 3. Designation of the roll box area on the side wall of the gin stand and the movement of the cotton.

Table 3. The effect of the speed of the saw cylinder on the composition of the seed roll.

Saw cylinder speed, rpm	Seed roll mass	Mass of bare seeds		Semi-ginned seed mass		Mass of non-ginned seeds	
	M, g	M, g	%	M, g	%	M, g	%
700	19,020	6919	36.4	11,048	58.1	1053	5.5
730	18,323	6525	35.6	10,452	57.0	1347	7.4
760	17,737	6238	35.2	10,342	58.3	1157	6.5

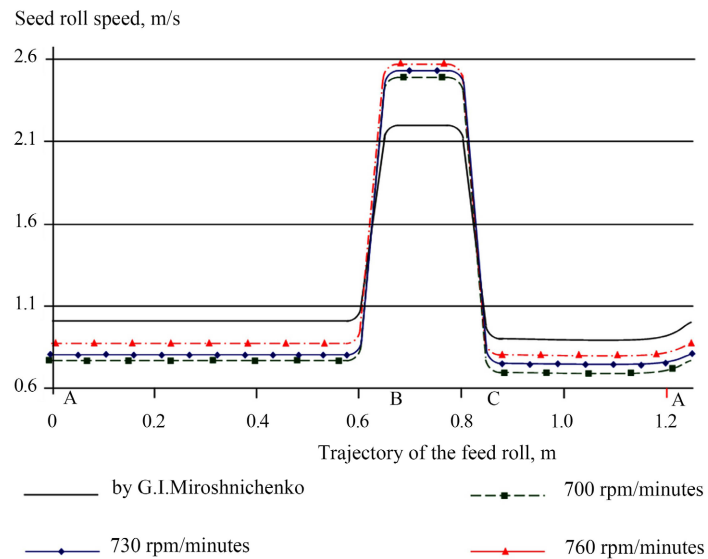
**Figure 4.** Distribution of the speed of the seed roll along the profile of the roll box.**Figure 5.** The composition of the seed roll in the roll box of the saw gin: (a) front view of the seed roll in the roll box, (b) bare seeds, (c) semi-ginned seeds, (d) non-ginned seeds.

Experiments have shown that on a 30-saw gin at a saw cylinder rotation speed of 730 rpm, 35.6% of the average mass of the seed roll was the mass of bare seeds, 57.0%—semi-ginned seeds and 7.4%—non-ginned seeds.

With a change in the speed of the saw cylinder from 700 rpm to 760 rpm, a decrease in the mass of the seed roll by 6.7%, of bare seeds by 1.2% was observed. Semi-ginned seeds accounted for 58.1% and 58.3%, and non-ginned seeds—5.5% and 6.5%, respectively.

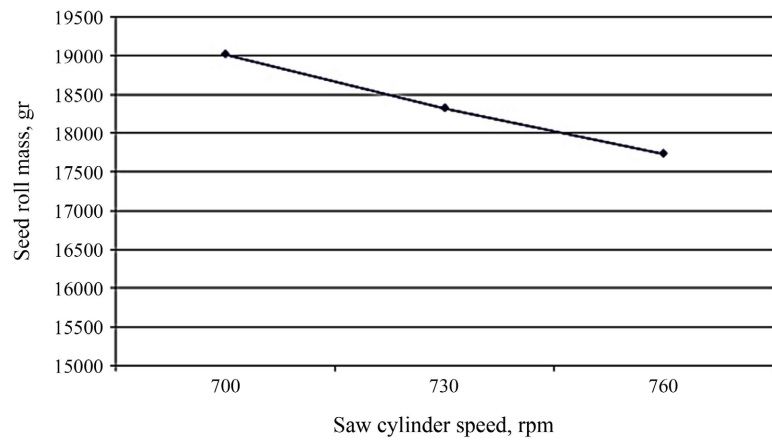

(a)

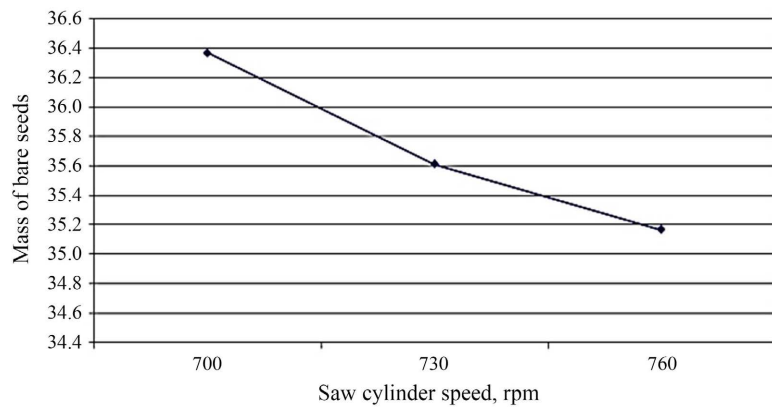

(b)

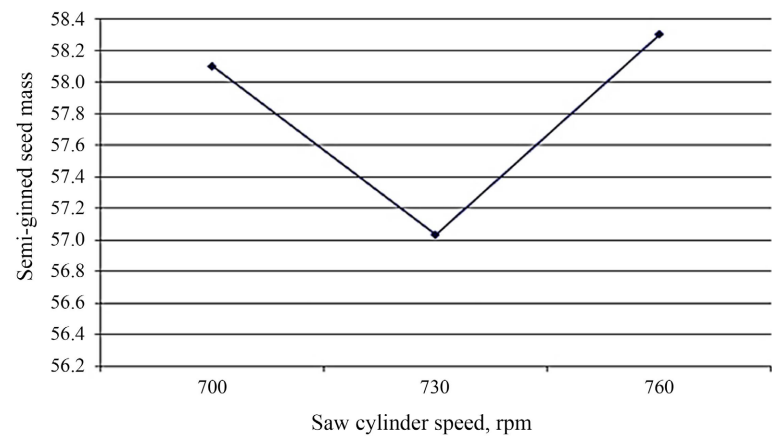

(c)

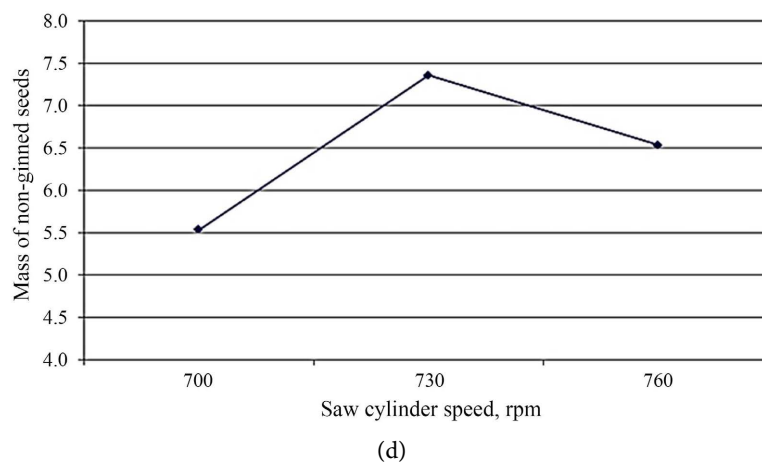

Figure 6. Graphs of the effect of the speed of the saw cylinder on the composition of the seed roll.

3. Conclusion

As can be seen from the above, the reason for the increase in the density of the seed roll is an increase in the number of bare seeds in the composition of the seed roll. And this, in turn, leads to damage to the fiber and seeds, and a decrease in the productivity of the machine. This means that adjusting the speed of the saw cylinder is of great importance to improve the quality of the fiber and seed.

Conflicts of Interest

The authors declare no conflicts of interest regarding the publication of this paper.

References

- [1] Bekmirzaev, B.I. (1989) Development of a Method for Regulating the Feeding of a Saw Gin According to the Air Permeability of a Seed Roll in Order to Improve the Quality of Fiber and Seeds. Dissertation of the Candidate of Technical Sciences, Tashkent.
- [2] Axmedxodjayev, Kh.T., Ortiqova, K. and Umarov, A. (2019) Investigation of the Ginning Process on ДП Series Saw Gin Stands. *Engineering*, **11**, 523-530. <https://doi.org/10.4236/eng.2019.118036>
https://www.scirp.org/html/6-8103257_94702.htm
- [3] Tillyaev, M.T. (1974) Investigation of the Influence of the Seed Roll Rotation Accelerator on the Main Indicators of the Ginning Process. Dissertation of the Candidate of Technical Sciences, Tashkent.
- [4] Miroshnichenko, G.I. (1972) Fundamentals of Designing Machines for Primary Processing of Cotton. Mechanical Engineering, Moscow.
- [5] Umarov, A., Ortikova, K. and Sarimsakov, A. (2020) Analysis of Speeds of Cylinders of Saw Gins and Linters and Determination of Critical Frequencies for Them. *Engineering*, **12**, 715-722. <https://doi.org/10.4236/eng.2020.1210050>
<https://www.scirp.org/journal/paperinformation.aspx?paperid=103378>